

Integrated Door Security Systems



Delayed Egress



Access Control



Automatically
Operated Doors



Electrified Dogging



Weatherized
Delayed Egress

One Part Number = One Easy Solution

Easy to Specify, Easy to Order, Easy to Price, Easy to Sell, Easy to Install,
Best-in-class products, kitted together for custom solutions to common applications.

Detex can create a more custom EasyKit for a specific application. Just contact
your local sales representative or email your request to marketing@detex.com

Where Trust is Built™

DETEX®

Integrated Door Security Systems

NOTES



Pre-wired,
pre-configured,
pre-simplified.

AUTOMATICALLY OPERATED DOOR

The Detex AOD EasyKit arrives with latch retraction power supply already integrated. Just install the operator, plug in, and you're in business. Self-contained operation, for the fastest, easiest install – that's the Detex effect.

Call 800-729-3839
detex.com/autodoor

DETEx[®]

MODEL NO.	DESCRIPTION	PRICE
AODx10ERx1S-43 For single door	<p>Low Energy Automatic Door, Latch Retraction Exit Device with Power Supply for RHR/LH/AL Push, Single Door</p> <p>Kit Includes:</p> <ul style="list-style-type: none"> (1) AO19-1 Low Energy Automatic Door Operator, Controller / Power Supply (1) Detex 10 Series device with Electric Latch Retraction, brushed stainless finish, for 36" door, when energized both pushpad and latch are retracted, Surface strike (#99), 03C night latch function pull trim with rim cylinder (1) Wiring diagram (1) Power Transfer - call ahead for template for door/frame prep (1) Wireless ADA, Knowing Act push buttons (kit includes 2 buttons) 	\$12,086

MODEL NO.	DESCRIPTION	PRICE
AODx21ERx1P-2 For pairs of doors	<p>Low Energy Automatic Door, Surface Vertical Rod Latch Retraction Exit Device with Power Supply for a Pair of Push, AL Doors</p> <p>Kit Includes:</p> <ul style="list-style-type: none"> (1) AO19-2 x CL x 75.5 Low Energy Automatic Door Operator, Controller / Power Supply (2) Detex 21 Series devices with Electric Latch Retraction, brushed stainless finish, for a pair of 36" x 84" doors, when energized both pushpad and latch are retracted, Surface strike (#97) (1) Wiring diagram (2) Power Transfer - call ahead for template for door/frame prep (2) NXG-IR-A Hardwired Switch (1) NXG-2Wire Module 	\$22,761

Contact factory for custom design EasyKits

EasyKits subject to additional restocking fee

NOTES



Danger approaches fast. Be faster.





MAIN ENTRY LOCKDOWN

Our solution keeps outside threats out with a click of a button, mouse, fob or key switch. Instant lockdown at a fraction of the cost of all-motorized latch retraction—that's the Detex effect.

Call 800-729-3839

detex.com/mainlockdown

DETEx[®]

MODEL NO.	DESCRIPTION	PRICE
<p>EDx10EDx1S-1 For single door</p>	<p align="center">Advantex Electrified Dogging Device with Power Supply and components for a Single Door</p> <p>Kit Includes: (1) Detex 10 Series Rim Exit Device with Electrified Dogging, brushed stainless steel finish, flex conduit loop, endcap and fittings, night latch pull trim (cylinder included) for 36" door width (1) Power Supply</p> <hr/> <div style="display: flex; justify-content: space-around; align-items: center;"> <div style="text-align: center;">  <p>Power Supply</p> </div> <div style="text-align: center;">  <p>99 Strike</p> </div> <div style="text-align: center;">  <p>03C Pull Trim</p> </div> <div style="text-align: center;">  <p>Advantex 10 Series Rim Exit Device</p> </div> </div> <p align="right">NOTE: Flex Conduit included (not shown)</p>	<p align="center">4,714</p>



Contact factory for custom design EasyKits

EasyKits subject to additional restocking fee

THIS PAGE INTENTIONALLY LEFT BLANK

THIS PAGE INTENTIONALLY LEFT BLANK



NOTES

MODEL NO.	DESCRIPTION	PRICE
<p>ACDx10xETDLx1S-1 For single door</p>	<p style="text-align: center;">Advantex Rim Exit Device with Trilogy® Exit Trim for Single Door</p> <p>Kit Includes: (1) Detex 10 Series rim device with hex dogging, brushed stainless finish, for 36" door, surface strike (1) Trilogy® Digital Keypad Exit Trim</p> 	<p>\$4,909</p>
<p>ACDx10xETDLx1S-2 For single door</p>	<p style="text-align: center;">Advantex Rim Exit Device with Trilogy® Exit Trim for Single Door</p> <p>Kit Includes: (1) Detex 10 Series rim device with hex dogging, brushed stainless finish, for 48" door, surface strike (1) Trilogy® Digital Keypad Exit Trim</p> 	<p>\$4,942</p>

Contact factory for custom design EasyKits

EasyKits subject to additional restocking fee

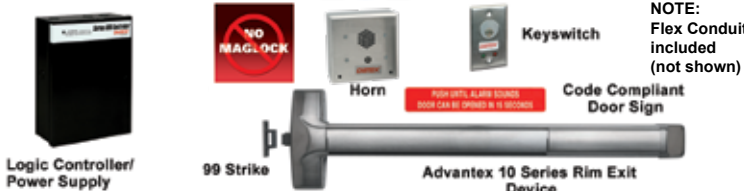
NOTES

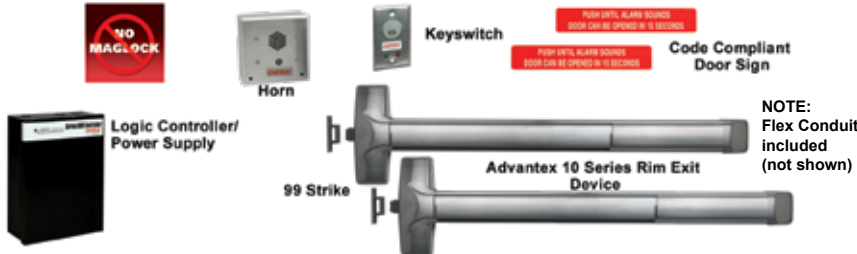
MODEL NO.	DESCRIPTION	PRICE
<p>DEx10EEXx1S-1 For single door</p> 	<p>Advantex Request-to-Exit Signal Rim Exit Device with Controller and components for Single Door</p> <p>Kit Includes:</p> <ul style="list-style-type: none"> (1) Detex 10 Series device, brushed stainless finish, for 36" door, pushpad activates signal switch - surface strike (#99), includes endcap with flexible conduit loop & fittings (1) Controller / Power Supply with wiring diagram (1) SRN5W - Horn with adjustable tone settings (1) Keyswitch with momentary switching (Mortise cylinder included) (1) ECL-395 Delayed Egress, Code-Compliant Peel & Stick Door Sign <hr/>  <p>NOTE: Flex Conduit included (not shown)</p>	<p>\$6,226</p>
<p>DEx10EEXx1P-1 For pairs of doors</p> 	<p>Advantex Request-to-Exit Signal Rim Exit Device with Controller and components for a Pair of Doors</p> <p>Kit Includes:</p> <ul style="list-style-type: none"> (2) Detex 10 Series devices, brushed stainless finish, for 36" door, pushpad activates signal switch - surface strike (#99), includes endcap with flexible conduit loop & fittings (1) Controller / Power Supply with wiring diagram (1) SRN5W - Horn with adjustable tone settings (1) Keyswitch with momentary switching (Mortise cylinder included) (2) ECL-395 Delayed Egress, Code-Compliant Peel & Stick Door Signs <hr/>  <p>NOTE: Flex Conduit included (not shown)</p>	<p>\$9,210</p>

Contact factory for custom design EasyKits

EasyKits subject to additional restocking fee

NOTES







Even out here,
you're in control.

OUTDOOR DELAYED EXIT

Detex offers the only weatherized solution out there, which means you can go beyond alarm-only setups and prevent instant exit in any outside setting. Delayed exit, from the leaders in rugged outdoor security – that's the Detex effect.

Call 800-729-3839
detex.com/outdoordelayed

DETEX[®]

MODEL NO.	DESCRIPTION	PRICE
<p>WDEx10EEXx1S-4 For single door</p> 	<p>Advantex Weatherized Request-to-Exit Signal Rim Exit Device with Controller and components for Single Door</p> <p>Kit Includes:</p> <ul style="list-style-type: none"> (1) Detex 10 Series Weatherized device, brushed stainless finish, for 36" door, pushpad activates signal switch - surface strike (#99), includes endcap with flexible conduit loop & fittings (1) Controller / Power Supply with wiring diagram in NEMA 4X enclosure (1) SRN5W - Outdoor Horn with adjustable tone settings (1) Keyswitch with momentary switching (Mortise cylinder included) (1) Protective Clear Plastic Cover for Keyswitch (not shown) (1) Metal Outdoor Delayed Egress, Code-Compliant Door Sign  <p>NOTE: Flex Conduit included (not shown)</p>	<p>\$9,049</p>
<p>WDEx10EEXx1P-4 For pairs of doors</p> 	<p>Advantex Weatherized Request-to-Exit Signal Rim Exit Device with Controller and components for a Pair of Doors</p> <p>Kit Includes:</p> <ul style="list-style-type: none"> (2) Detex 10 Series Weatherized devices, brushed stainless finish, for 36" door, pushpad activates signal switch - surface strike (#99), includes endcap with flexible conduit loop & fittings (1) Controller / Power Supply with wiring diagram in NEMA 4X enclosure (1) SRN5W - Outdoor Horn with adjustable tone settings (1) Keyswitch with momentary switching (Mortise cylinder included) (1) Protective Clear Plastic Cover for Keyswitch (not shown) (2) Metal Outdoor Delayed Egress, Code-Compliant Door Signs  <p>NOTE: Flex Conduit included (not shown)</p>	<p>\$12,496</p>

Contact factory for custom design EasyKits

EasyKits subject to additional restocking fee

THIS PAGE INTENTIONALLY LEFT BLANK